

λ Anomaly in the Heat Capacity of Solid Hydrogen at Small Molar Volumes*†

G. AHLERS‡,§ AND W. H. ORTTUNG¶

*Inorganic Materials Research Division, Lawrence Radiation Laboratory and Department of Chemistry,
University of California, Berkeley, California*

(Received 31 October 1963)

Apparatus for the determination of properties of solid hydrogen at volumes between 15 and 23 cc/mole is described. The results of measurements on the λ anomaly in the heat capacity of solid hydrogen containing large concentrations of orthohydrogen are reported for molar volumes from 15.8 to 22.6 cc. The λ temperature was found to vary with intermolecular separation R as R^{-5} , with a small contribution from a higher exponent. This is in agreement with the expected relative contributions of electric quadrupole and valence interactions to the intermolecular potential. The relative contribution of the λ anomaly to the total anomalous entropy was estimated. The λ anomaly was found to have at least two distinct peaks.

I. INTRODUCTION

THE possibility of molecular rotation in solid hydrogen was first considered by Pauling,¹ and it was suggested at about the same time by Simon that there should be a rotational contribution to the heat capacity of solid orthohydrogen.² Soon after these ideas originated Mendelssohn *et al.* did indeed observe the high-temperature end of an anomalous contribution in solid solutions of ortho- and parahydrogen.³ Theoretical analysis of these data revealed that the anomaly was more complicated than the common Schottky type.⁴ This idea was confirmed by the measurements at lower temperatures by Hill *et al.*,^{5,6} who observed that the heat capacity had a sharp maximum of the λ type at about 1.5°K for orthohydrogen concentrations greater than 62%; the total anomalous entropy was $R \ln 3$ per mole orthohydrogen. An anomalous contribution to the heat capacity of solid deuterium was found by Gonzalez *et al.*⁷ But because the largest available concentration of the species in the $J=1$ state (para D_2) was 33% at the time of these measurements, no λ anomaly was observed. Recently it has become possible to prepare deuterium samples of greater para concentration, and Grenier and White observed a λ anomaly in the heat capacity of para-enriched deuterium as well.⁸

There has been considerable theoretical work on the anomalous heat capacity of solid hydrogen and deuterium since the original work by Pauling,¹ Simon,² and Schaefer.⁴ Tomita attributed the anomalous heat capacity to a removal of the threefold degeneracy of the $J=1$ rotational level of orthohydrogen (or paradeuterium) by the electric quadrupole interaction between neighboring ortho molecules in the crystal.⁹ He applied the theory of cooperative transitions to this interaction in the Bragg-Williams and the Bethe-Peierls approximations. The theoretical results agree reasonably with the experimental λ temperatures as a function of concentration; but the theoretical minimum concentration of orthohydrogen for the existence of the λ anomaly is much lower than observed. At about the same time, Nakamura¹⁰ developed a theory that was applicable to the high-temperature end of the anomaly, and he obtained results in reasonable agreement with Hill and Ricketson's data.⁵ The case of low-ortho concentration was considered by Nakamura,¹⁰ by Nakamura and Uryu,¹¹ and, in greater detail, by Orttung.¹²

In addition to the λ anomaly in the heat capacity, the cooperative transition at high orthohydrogen concentrations has also been observed by nuclear-magnetic-resonance (NMR) experiments.¹³⁻¹⁸ The NMR transition temperature agrees reasonably with the λ temperature in the heat capacity, and it is believed to be caused by the same interactions.¹⁴

The present work was undertaken to study the effect of volume changes on the λ anomaly. Solid hydrogen, because of its large zero-point energy, is very compressible, and the opportunity to study intermolecular interactions over a large volume range thus exists. The heat

* Based on parts of theses submitted in partial fulfillment of the requirements for the Ph.D. degree, University of California, Berkeley, California.

† Research supported by the U. S. Atomic Energy Commission.

‡ National Science Foundation Predoctoral Fellow, 1960-1961; and General Electric Company Predoctoral Fellow, 1961-62.

§ Present address: Bell Telephone Laboratories, Murray Hill, New Jersey.

¶ Bell Telephone Laboratories Predoctoral Fellow, 1958-59; and National Science Foundation Predoctoral Fellow, 1959-60.

¶ Present address: Department of Chemistry, University of California, Riverside.

¹ L. Pauling, *Phys. Rev.* **36**, 430 (1930).

² F. Simon, *Ergeb. Exakt. Naturw.* **9**, 260, 269 (1930).

³ K. Mendelssohn, M. Ruhemann, and F. Simon, *Z. Physik Chem. (Leipzig)* **B15**, 121 (1931).

⁴ K. Schaefer, *Z. Physik Chem. (Leipzig)* **B42**, 380 (1939).

⁵ R. W. Hill and B. W. A. Ricketson, *Phil. Mag.* **45**, 277 (1954).

⁶ R. W. Hill, B. W. A. Ricketson, and F. Simon, *Conference de physique des basses temperatures, Paris, 1955* (Simon et Cie, Paris, 1955), No. 76, p. 317.

⁷ O. D. Gonzalez, D. White, and H. L. Johnston, *J. Phys. Chem.* **61**, 773 (1957).

⁸ G. Grenier and D. White, *J. Chem. Phys.* **37**, 1563 (1962).

⁹ K. Tomita, *Proc. Phys. Soc. (London)* **A68**, 214 (1955).

¹⁰ T. Nakamura, *Progr. Theoret. Phys. (Kyoto)* **14**, 135 (1955).

¹¹ T. Nakamura and N. Uryu, *Busseiron Kenkyu* **96**, 49 (1956).

¹² W. H. Orttung, *J. Chem. Phys.* **36**, 652 (1962).

¹³ J. Hatton and B. V. Rollin, *Proc. Roy. Soc. (London)* **A199**, 22 (1949).

¹⁴ F. Reif and E. M. Purcell, *Phys. Rev.* **91**, 631 (1953).

¹⁵ T. Sugawara, T. Masuda, T. Kanda, and E. Kanda, *Sci. Rept. Res. Inst. Tohoku Univ.* **7**, 67 (1955).

¹⁶ T. Sugawara, *Sci. Rept. Res. Inst. Tohoku Univ.* **8**, 95 (1956).

¹⁷ G. W. Smith and R. M. Housley, *Phys. Rev.* **117**, 732 (1960).

¹⁸ W. D. McCormick, Ph.D. thesis, Department of Physics, Duke University, Durham, North Carolina, 1959 (unpublished).

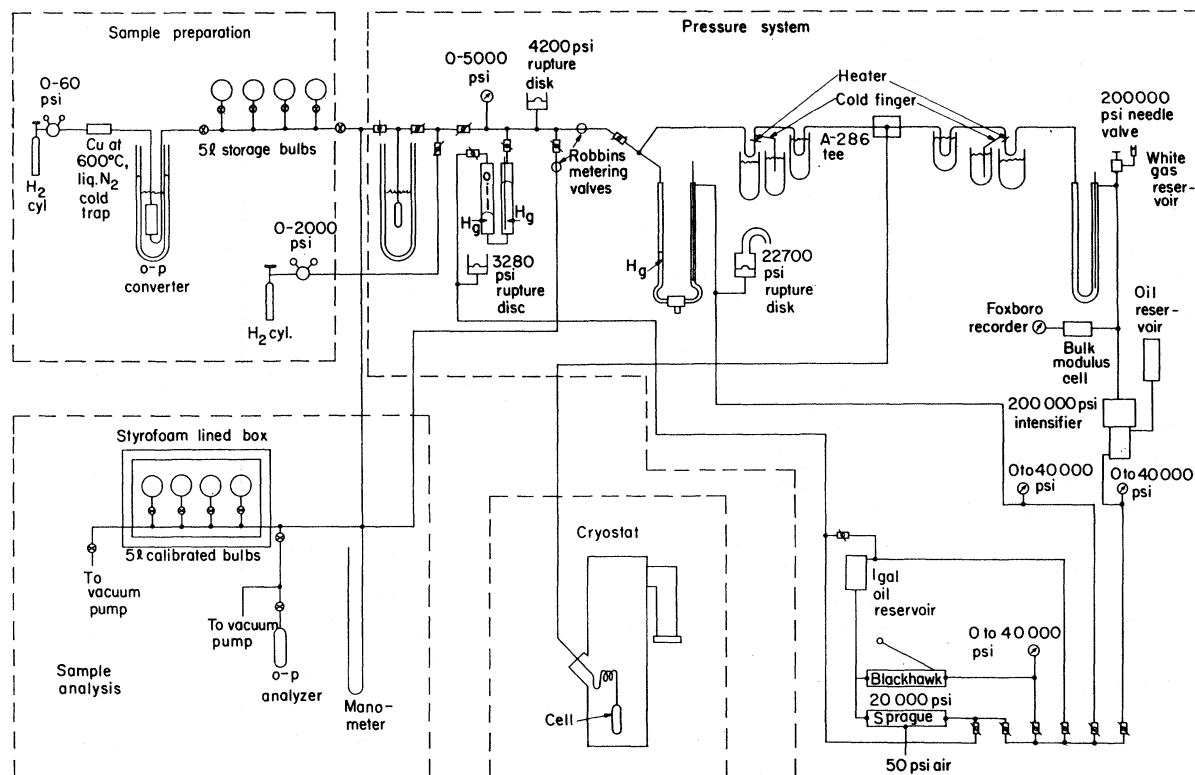

FIG. 1. Schematic diagram of the apparatus.

capacity in the vicinity of the λ anomaly was determined as a function of volume and orthohydrogen concentration. In order to confirm and possibly extend earlier work,^{5,6} some experiments were also performed at zero applied pressure. In this paper the apparatus necessary for the measurements is briefly described, and the results of the heat-capacity measurements on the λ anomaly in solid hydrogen at molar volumes between 15.9 and 22.6 cc/mole are presented. These results confirm some of the theoretical deductions; but they also show that the nature of the λ anomaly is too complicated to be completely understood on the basis of present theoretical work.

II. APPARATUS

Because of the complex nature of the apparatus necessary for the experiments, it is not practicable to give a detailed description here; such a description is available elsewhere.^{19,20} A general description of the apparatus follows.

Basically the apparatus consisted of four parts: the sample-preparation units, and pressure-generating system, the cryostat, and the sample-analysis units. A schematic diagram is given in Fig. 1.

¹⁹ W. H. Orttung, Ph.D. thesis, Lawrence Radiation Laboratory Report UCRL-9388, 1961 (unpublished).

²⁰ G. Ahlers, Ph.D. thesis, Lawrence Radiation Laboratory Report UCRL-10757, 1964 (unpublished).

A. Sample-Preparation Units

The hydrogen samples used were prepared electrolytically, purified over silica gel at 78°K, and stored at about 2000 psi in steel cylinders. Before use the gas could be passed over copper at 1 atm pressure and at 600°C, and then through a liquid-nitrogen cold trap. Depending on the concentration of orthohydrogen desired, the sample could then be passed through a ferric oxide catalyst at room temperature, 78 or 20°K. This procedure yielded 75%, 50%, or 0.2% orthohydrogen concentrations, respectively. Other desired concentrations between 0.2% and 75% could be made by appropriate mixing. After preparation the sample could be stored in four 5-liter glass bulbs.

B. Pressure System

The pressure system consisted of a condensing bomb, followed by a series of three U tubes half-filled with mercury, and the cell. The sample could be condensed out of the 5-liter bulbs in the sample-preparation system by admitting it to the bomb surrounded by solid hydrogen. It was then allowed to expand into one arm of the first U tube. This was accomplished by warming the bomb above the normal boiling point. The pressure obtained in this manner was about 10 atm. Oil pressure was then applied to the other arm of the U tube, and the sample was pushed into a second U tube of smaller

volume and heavier design. Alternatively, the sample could be admitted directly from a steel cylinder at pressures up to 2000 psi to this second U tube. By a similar procedure, the sample was pushed into a third U tube, and finally into the high-pressure cell in which the thermal measurements were made. The pressure increased approximately by a factor of 10 in each stage, so that a final pressure of about 10 000 atm could be reached.

Mechanical valves were used to confine the sample in the various stages up to the inlet to the second U tube. Beyond that point, the successive pressure gradients were supported by mercury frozen in stainless steel capillaries.

The mercury level in the U tubes was measured by means of an insulated wire dipped into the mercury. This wire served as a capacitor in one arm of an ac bridge. The bridge unbalance, and therefore the mercury level, was indicated on an ac volt meter.

The pressure was generated by an air-operated pump. It was transmitted by hydraulic oil to the first and second U tube, and to an intensifier. Pressures above 20 000 psi were needed in the last U tube, and were generated in an intensifier. White gasoline (hexanes) was used as a pressure-transmitting fluid between the intensifier and the last U tube. A hand pump was also in the system, and it could be used instead of the air-operated pump.

The parts of the system exposed to pressures above 20 000 psi were connected by means of cold-worked 316 stainless steel capillary tubing, $\frac{1}{8}$ -in. o.d. and 0.5-mm i.d.

The sample was sealed in the high-pressure cell by the solid hydrogen plug in the capillary.

C. Cryostat

A schematic diagram of the cryostat is given in Fig. 2. The cryostat had one vacuum system that was composed of the outer casing A, an MCF 300 diffusion pump B, a gate valve C, a water-cooled baffle D, and a forepump line E. The bottom section of the casing was removable at flange F for access to the high-pressure cell.

Inside the vacuum system there were the three baths G, H, and I for liquid nitrogen, hydrogen, and helium, respectively. The inner bath I was suspended by its pump tube from the outer bath H. Separate Kinney pumps were used to pump down baths H and I. Copper shields K and L were attached to the liquid-nitrogen (G) and hydrogen (H) baths, respectively, to thermally protect the lower region of the calorimeter. The bottom sections of these shields were detachable for access to the high-pressure cell. A third shield M protected the cell. Its temperature could be regulated above the helium bath temperature in order to control the heat leak out of cell N. The cell could be cooled to the helium bath temperature by means of a mechanical heat switch P. The capillary R was thermally attached to the

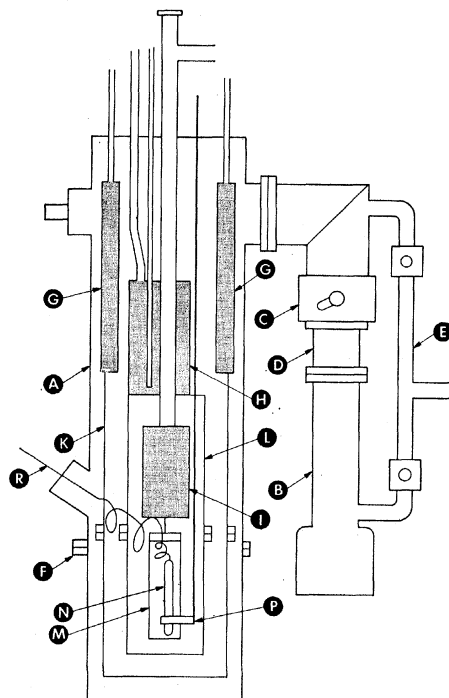

FIG. 2. Schematic diagram of the cryostat.

various shields and connected the cell to the high-pressure system. Temperatures were measured with a germanium thermometer calibrated against the vapor pressure of liquid helium.

D. Sample-Analysis Units

The orthohydrogen concentration of the samples was determined by measuring the thermal conductivity of the gas. The amount of sample used in an experiment was determined by expanding the sample into calibrated 5-liter glass bulbs, thermostated at room temperature, and measuring the pressure of the gas after expansion.

III. EXPERIMENTAL METHODS

Heat-capacity measurements at high orthohydrogen concentrations present difficulties not encountered in other samples, due to the heat generated by the ortho-para conversion in the sample. Hill and Ricketson⁵ discussed this problem to some extent. The rate of heat generation due to the conversion is given by

$$dH/dt = -(n\Delta H/360\,000)(dq/dt), \quad (1)$$

where (dH/dt) is in milliwatts if n is the number of moles of sample, ΔH is the heat of conversion in millijoules per mole, and (dq/dt) is the rate of conversion in % orthohydrogen per hour. It will be assumed here that the perturbation of the $J=0$ and $J=1$ levels is small compared with the energy difference between these levels, and that therefore the value $\Delta H=1430$

J per mole orthohydrogen for the gas phase can be used. If, furthermore, the conversion follows a second-order rate law, then

$$(dH/dt) = 3.98kq^2n, \quad (2)$$

where k (the rate constant) is in $(\% \text{ hours})^{-1}$ and q is in $\%$ orthohydrogen. At a molar volume of 22.6 cc the rate constant is $18 \times 10^{-5} (\% \text{ hours})^{-1}$. This corresponds to a rate of heat generation of 4 mW/mole of sample. At the highest densities studied this rate increased by about a factor of four. Even though the samples had a rather large heat capacity in the anomalous region, this heat generation caused rapid warming. The temperature of the λ anomaly could of course easily be observed when the sample was allowed to warm on its own accord. Estimates of the heat capacity in the region of the λ anomaly were possible from the rate of temperature change, if one assumed that the rate of conversion was constant in the region of the anomaly, and if reasonable thermal equilibrium existed throughout the sample. Direct measurement of the heat capacity was possible only above the λ point, and in this region the rate of conversion could be determined by comparing the drifts with the measured heat capacity. The rate of conversion was also determined from the initial and final concentration. An additional difficulty arose from the fact that the sample composition changed with time. The composition at any given time could of course be calculated from the conversion rate and the thermal history of the sample. This method has been used by others.¹⁷

The primary interest in this work on samples of high orthohydrogen concentrations was in the λ anomaly. For this reason most of the measurements consisted of determining heating curves rather than of measuring heat capacities directly by conventional methods. In general, the heating curves are related to the heat capacity and to the rate of heat generation by the relation

$$dt/dT = C/(dH/dt). \quad (3)$$

With the aid of Eq. (2) this becomes

$$dt/dT = C/3.98kq^2n, \quad (4)$$

and thus for the heat capacity per mole,

$$C = 3.98kq^2(dt/dT), \quad (5)$$

provided that the heat capacity of the empty cell is negligible. In the region of the λ anomaly this is certainly the case.

In order to reduce the effort of numerical computations, heat capacities, temperatures and entropy changes were calculated from thermometer resistances and heating times by means of an IBM 650 data processing machine.

Whenever heat capacities are calculated from heating curves, the possibility of errors due to thermal gradients in the sample exists. In these measurements on the λ anomaly the most severe thermal gradients were

present when the thermal switch was closed. After opening of the thermal switch, the temperature at the outside of the cell rose very rapidly for a few seconds. This was due to relaxation of the gradients. With the sample thermally isolated the only heat flow across the sample is that which is necessary to heat the cell at the same rate at which the sample is warming, because the rate of heat generation inside the sample is uniform. Because of the high thermal diffusivity exhibited by the beryllium copper during measurements on the empty calorimeter, we feel that thermal gradients in the cell and sample were small after the initial gradients relaxed. But it was necessary to cool well below the λ temperature in order to obtain reliable estimates of the entropy involved in the λ anomaly.

In order to estimate experimentally the effect of any thermal gradients in the sample on the measured heat capacity, two experimental approaches were used. One of them consisted of determining heating curves after the disappearance of the λ anomaly with various external heat inputs, and the other consisted of studying the effect of cell geometry on the λ anomaly. In the first approach the external heat input varied from zero to 0.2 mW. The internal rate of heat generation was about 0.15 mW. Alternate heating curves were taken without external-heat input. The internal rate of heat generation during the heating curves with external-heat input was estimated by interpolation. For the heating rate with external-heat input one has from Eq. (4)

$$(dt/dT)_i = C/(3.98kq^2n + P_i), \quad (6)$$

where P_i is the heater power. One can now form the ratio

$$\frac{(dt/dT)}{(dt/dT)_i} = D_i = 1 + \frac{P_i}{3.98kq^2n}, \quad (7)$$

where (dt/dT) is the quantity obtained with the heater off. It is seen that D is independent of C , and at constant T should be linearly dependent on P/q^2 , even if the rate constant k were temperature-dependent. D was found to vary according to Eq. (7) for $1.7^\circ\text{K} \leq T \leq 2.7^\circ\text{K}$. The scatter in D was about 6%. At 1.6°K , the lowest temperature at which these measurements could be made, D increased more rapidly than P/q^2 , and at a heater power of 0.1 mW was 18% too large. These measurements show that reasonable thermal equilibrium existed in the sample after the initial relaxation. The slight deviation from thermal equilibrium at 1.6°K was due to this initial thermal gradient that must be expected with the heat switch closed. With the switch closed and no external heat input, it was possible to cool the sample to 1.46°K . Inspection of dt/dT versus T curves indicated that the initial gradient completely relaxed just above 1.6°K . Thus, with this particular rate of heat generation, it was necessary to cool about 0.15°K below the λ anomaly in order for the initial thermal gradient to relax before the λ anomaly was reached. The values

of D were also found to be independent of temperature. Within the stated experimental error for D , the rate constant was thus temperature-independent.

The other approach to estimating the effects of thermal gradients consisted of varying the cell geometry. Measurements were made in two cells. In one cell, identified as I, the sample was $\frac{3}{4}$ in. long and $\frac{1}{4}$ in. thick, and in the other cell, identified as II, the sample was $3\frac{5}{8}$ in. long and 0.094 in. thick. Measurements of the entropy involved in the λ anomaly yielded the same results in the two cells. The λ temperatures also differed by less than what can be expected from other errors. However, the anomaly at constant volume was much broader in cell II than in cell I. Because of the high thermal diffusivity of the beryllium copper, the opposite effect might be expected because any severe thermal gradients would be in the sample or at the boundary between the sample and the cell. It is believed that the broadening in cell II was due to pressure gradients in the cell. The magnitude of the broadening was consistent with Stewart's extrusion data on solid hydrogen.²¹

During the measurements at small molar volumes some additional difficulties were experienced because of the severe experimental conditions. The sample was introduced into the cell at 78°K. It was important to accomplish this and to cool well below the λ temperature as rapidly as possible because of the large increase in the ortho-para conversion rate with decreasing molar volume. This made it necessary to use the samples directly from the hydrogen cylinder at about 100 atm, because the time involved in the initial compression of the sample would have been too long to be tolerable. The initial concentration of orthohydrogen thus was always 75%. The maximum concentration at which the λ anomaly could be observed varied somewhat with molar volume but generally was about 69% orthohydrogen.

Because the sample size had to be as small as 0.6 cc in order to make cooling by means of the mechanical heat switch possible, any determination of the sample density by a direct method would have been subject to rather large errors. Furthermore, in order to obtain a representative sample for the ortho-para analysis, the fraction of the sample in the capillary had to be discarded. The amount of sample could thus not easily be measured. It was therefore not feasible to determine the density of the sample directly. An attempt to use the filling pressure and temperature to estimate the density yielded densities that seemed too low for the temperature at which the λ anomaly occurred. This is believed to be due to movement of the solid plug in the capillary when the sample was cooled below 78°K. In view of the fact that no time could be lost at high temperatures because of the change in sample composition, it was not possible to adjust experimental conditions so that no plug movement occurred in the capillary. It was thus

necessary to use an indirect method to determine the molar volumes of the samples. The volumes were estimated from the volume dependence of the second-order rate constant of the ortho-para conversion.²² The rate constant was determined for each sample from the initial and final concentration. The maximum error in any individual rate-constant determination was estimated to be $\pm 5\%$. The associated maximum error in the molar volume is ± 0.5 cc. For the rate-constant determinations it was found important to discard the hydrogen in the capillary. During the early experiments this was not realized, and the results of these experiments were used only for general considerations in which the molar volumes and concentrations are not critical. During the later experiments the hydrogen in the capillary was discarded by warming the sample to 14°K, by permitting the capillary plug to break, and by pumping out the pressure system before the rest of the sample was expanded.

IV. THE λ ANOMALY AT ZERO PRESSURE

With the apparatus used here, only concentrations above about 70% orthohydrogen could be studied. At lower concentrations the λ temperature is too low and is not experimentally accessible. Although the bath can be cooled to 1.28°K, the thermal gradient across the heat switch is about 0.1°K. The discussion on thermal gradients shows that an additional thermal gradient of about the same magnitude exists in the cell with the thermal switch closed. Thus the minimum temperature at which the λ anomaly can be observed is about 1.48°K.

Two experiments were carried out at 0 pressure, or a volume of 22.64 cc/mole. In experiment I the cell was precooled to 14.5°K. The sample was withdrawn from the steel cylinder, passed over copper at 600°C, then through a liquid nitrogen cold trap, and then through the ortho-para converter at room temperature. After this it was permitted to condense in the cell until the cell was full. In experiment II the cell was precooled to 20°K, and the sample was admitted directly from the steel cylinder at a delivery pressure of 300 psi. The gas in the cylinder had been prepared electrolytically, purified over silica gel at 78°K, and stored at 2000 psi for over 1 year in the cylinder before use. This same cylinder was used for all constant-volume measurements on the λ anomaly as well. In both experiments liquid helium was transferred as soon as the sample had been introduced, and cooling below the λ anomaly was carried out as rapidly as possible. The results of the two experiments were essentially identical.

A previously unreported feature of the λ anomaly is the existence of structure. The anomaly is not a single λ -shaped transition such as is found in liquid helium, but rather has three distinguishable maxima. This is illustrated in Figs. 3, 4, and 5 for three different con-

²¹ J. W. Stewart, *Phys. Rev.* **97**, 578 (1955).

²² G. Ahlers (to be published).

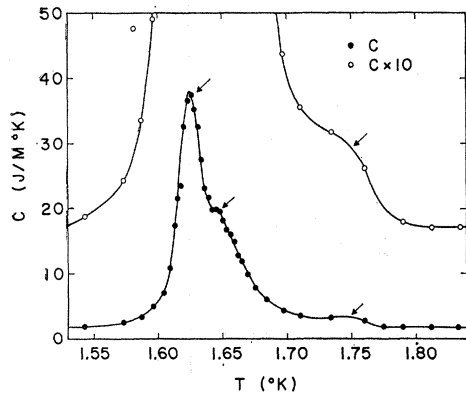

FIG. 3. The λ anomaly at zero pressure and 74.1% orthohydrogen. The arrows indicate distinguishable peaks. The sample had not been cooled sufficiently far to remove all the entropy of the λ anomaly.

centrations of orthohydrogen. The maximum at the lowest temperature invariably was the largest of the three. It commonly, but not always, showed a side peak at a temperature about 0.015 to 0.025°K higher than the main peak. This side peak was not always observable, possibly because of its proximity to the larger main peak. In addition there appeared a third much smaller maximum at a temperature about 0.1°K higher than the main peak.

If Fig. 6 the λ temperatures are plotted against concentration of orthohydrogen. All maxima that appeared in the heating curves are shown, and those belonging to the same heating are connected by a solid line. The data

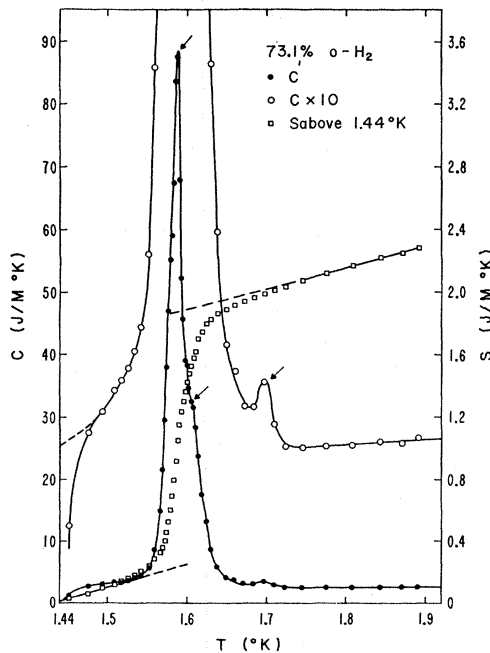

FIG. 4. The λ anomaly at zero pressure and 73.1% orthohydrogen. The arrows indicate distinguishable peaks.

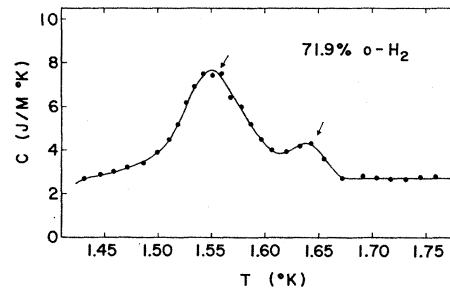

FIG. 5. The λ anomaly at zero pressure and 71.9% orthohydrogen. The arrows indicate distinguishable peaks.

of Hill *et al.*^{5,6} and of Smith and Housley¹⁷ are also shown. The agreement of the temperature for the main peak with the λ temperature observed by Hill *et al.* is very satisfactory.

In these measurements the various concentrations were obtained by waiting for the ortho-para conversion to proceed below the minimum temperature for self-diffusion. Under these conditions the λ transition disappeared at a concentration of 71.5% orthohydrogen. In experiment I the sample was melted at a concentration of 71.4%, and then recooled. This caused the λ anomaly to appear again, at temperatures in agreement with extrapolation from higher concentrations. Hill *et al.* were able to observe the λ anomaly at concentrations as low as 62.7%, and in view of the present results they presumably used fresh samples for each heating curve.

Hill and Ricketson⁵ pointed out that above the λ anomaly the anomalous heat capacity decreases more slowly than is encountered in other cooperative transitions. An unusually large fraction of the total anomalous entropy is found at temperatures larger than T_λ . This may indicate that only a fraction of the ortho molecules participates in the cooperative transition that leads to the λ anomaly.

So far there has been essentially no information on the entropy involved in the λ anomaly. For those heating curves for which cooling well below the λ anomaly was possible, the entropy involved in the λ transition was

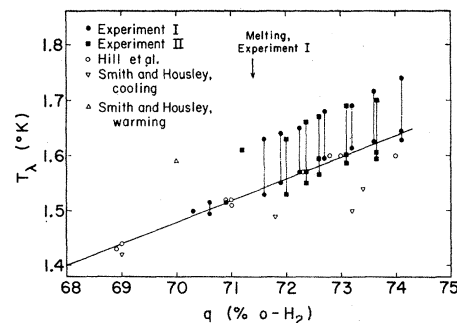

FIG. 6. The λ temperature as a function of concentration at zero pressure. The points connected vertically are separate peaks observed during the same heating. The arrow labeled melting experiment I indicates the concentration at which the sample was melted and recooled.

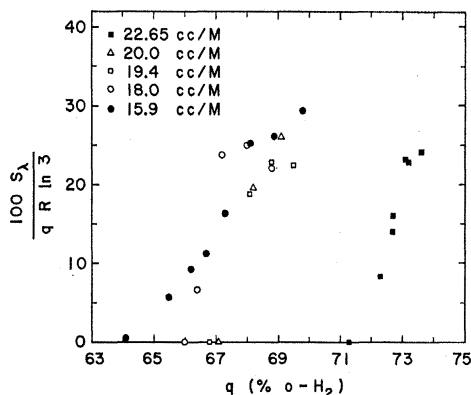

FIG. 7. The relative contribution (at several molar volumes) of the λ anomaly entropy as a function of concentration.

determined by plotting the entropy above the minimum experimental temperature against temperature. In this graph the entropy above and below the λ transition can easily be extrapolated to the λ temperature, and the change in entropy due to the λ transition can thus be determined. This procedure is illustrated in Fig. 4. Between 73 and 74% orthohydrogen the entropy involved in the λ anomaly amounts to about 23% of $R \ln 3$ per mole orthohydrogen. The contribution of the λ anomaly rapidly decreases as the concentration decreases. The relative entropy contribution of the λ anomaly is plotted against concentration of orthohydrogen in Fig. 7. It must be remembered that these entropy values are obtained from samples whose composition changed at temperatures below the minimum self-diffusion temperature²³ and whose original concentration was 75% orthohydrogen. No reliable entropy values could be obtained after melting and recooling, because the λ temperature was too low.

V. THE λ ANOMALY AT SMALL MOLAR VOLUMES

The only previous study of the effect of volume changes on the λ temperature is that by McCormick.¹⁸

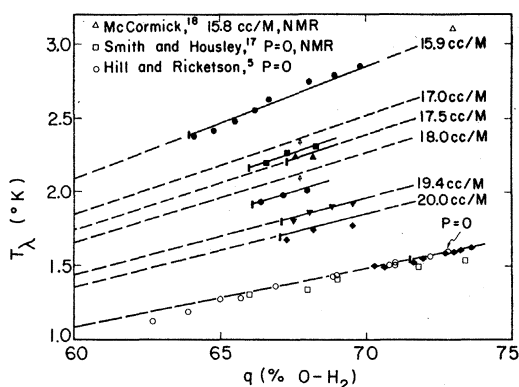

FIG. 8. The λ temperature as a function of concentration at several molar volumes.

²³ G. W. Smith and C. F. Squire, Phys. Rev. **111**, 188 (1958).

He reported that at a pressure of 2300 atm ($V = 15.8$ cc/mole), NMR measurements indicate that T_λ had been raised to 3.1°K to be compared with 1.6°K at zero pressure. McCormick's concentration was not specified, but presumably it was in the vicinity of 73% orthohydrogen.

A number of measurements are reported here for several molar volumes between 15.8 and 22.6 cc. Except for the additional difficulties mentioned earlier, the measurements were similar to those at zero pressure.

The λ temperature as a function of orthohydrogen concentration is given in Fig. 8 for several molar volumes. For comparison, some of the data for zero pressure are also reproduced here. It is clear that the λ anomaly is strongly affected by changes in the molar volume. Again the changes in concentration are due to the ortho-para conversion at temperatures at which no self-diffusion occurred.

The minimum concentrations at which the λ anomaly existed are indicated by a vertical bar. Two samples at a molar volume of about 18 cc/mole were heated above their melting temperature in an attempt to regenerate the λ anomaly. After melting, no λ anomaly was found at a concentration of about 65%. This is quite different from that found at zero pressure. There is a considerable scatter in the minimum concentration at which the λ anomaly existed, and it is believed that this scatter is due primarily to uncontrolled variations in the thermal histories of the samples, but it is apparent that the minimum concentration for the λ anomaly decreases with decreasing molar volume.

The volume dependence of the λ anomaly was estimated at a concentration of 68%. This concentration was chosen because data are available for all molar volumes studied. The λ temperature at 68% orthohydrogen is plotted against molar volume on a logarithmic scale in Fig. 9. The λ temperature changes with the intermolecular separation R as R^{-5} , with a small contribution from R^{-n} , where n is larger than 5. The data

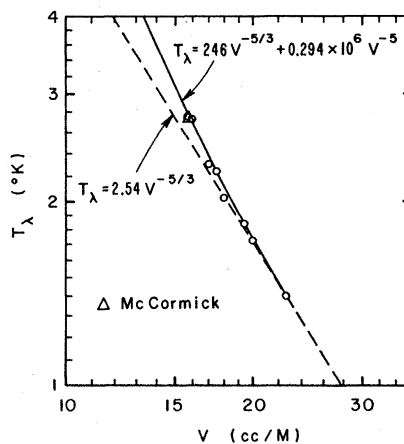

FIG. 9. The λ temperature as a function of molar volume at 68% orthohydrogen.

were fitted to an R^{-5} plus and R^{-15} term, using the zero pressure and 15.9 cc/mole data. The concentration dependence can be expressed by a linear relation over the small concentration range of the experiments, and it was estimated from the zero-pressure data. These data were used because they show by far the least scatter. Within experimental error the λ anomaly as a function of concentration and volume is given by

$$T_\lambda = (-226 + 6.93q)(V^{-5/3} + 1.20 \times 10^3 V^{-5}), \quad (8)$$

where q is the orthohydrogen concentration in percent. The lines corresponding to this equation and the estimated molar volumes of the experiments are given in Fig. 8. The largest difference between Eq. (8) and the experimental data is 0.1°K , and corresponds to an error in the molar volume of 0.5 cc/mole. This is consistent with the maximum error estimated for the rate-constant determinations.

As was found at zero pressure, the data at smaller molar volumes also show that the λ anomaly is not a simple maximum. Frequently two distinct peaks were observed. Four sets of heat capacities are shown in Fig. 10. These data were taken in cell II, and the transitions are rather broad because of pressure gradients in the cell. This broadening lowered the maximum heat capacity considerably and makes it somewhat difficult to distinguish the two peaks. In Fig. 11 the heat capacities for measurements under similar conditions in cell I and cell II are shown. Figure 11(a) clearly shows the doublet. Occasionally at the smaller molar volumes only a single peak could be observed. The relative sizes of the peaks did not seem to follow any definite relation, and were probably affected by uncontrolled differences in thermal histories. The temperature difference between the two peaks also seemed to be affected by uncontrolled variables, but in general increased with decreasing molar volume. At 15.9 cc/mole, it was of the order of 0.1°K .

The entropy of the λ anomaly as a function of concentration could be most easily measured at zero pressure, and at the smallest molar volumes. At zero pressure no time was spent in cooling from 78°K , and at the smallest molar volumes less time was spent cooling to very low temperatures because the λ anomaly occurred at relatively high temperatures. The greatest

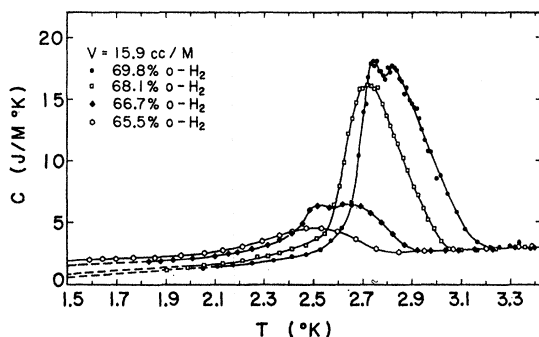

FIG. 10. The λ anomaly at 15.9 cc/mole.

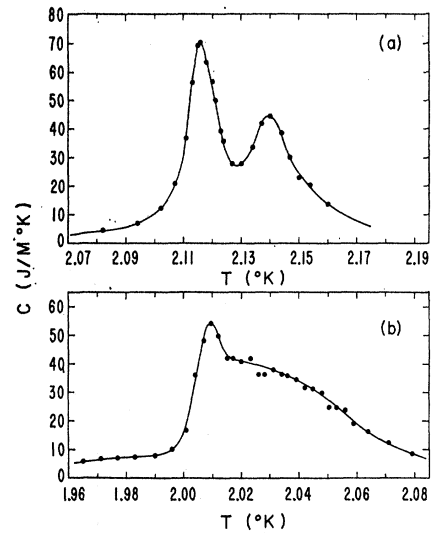

FIG. 11. Typical shapes of the λ anomaly at small molar volumes. (a) and (b) were measured in cells I and II, respectively, under similar conditions.

concentration ranges could thus be studied at 22.65 cc/mole and 15.9 cc/mole. Some information was also obtained at other molar volumes. The relative contribution of the λ anomaly to the total anomalous entropy is shown in Fig. 7. At all molar volumes studied the entropy of the λ anomaly decreased very rapidly with concentration. The decrease at the smaller molar volumes was perhaps not quite as fast as it was at zero pressure.

Because of the rapid disappearance of the λ anomaly, part of its entropy must appear in the entropy of the broad anomaly. No appreciable change in the heat capacity was ever observed at temperatures immediately above the λ anomaly. At the smallest molar volumes the λ anomaly occurred at sufficiently high temperatures to make it possible to observe the heat capacity below the λ anomaly. In this region the heat capacity changed by about a factor of 2 while the λ anomaly disappeared. This change is shown in Fig. 12 for

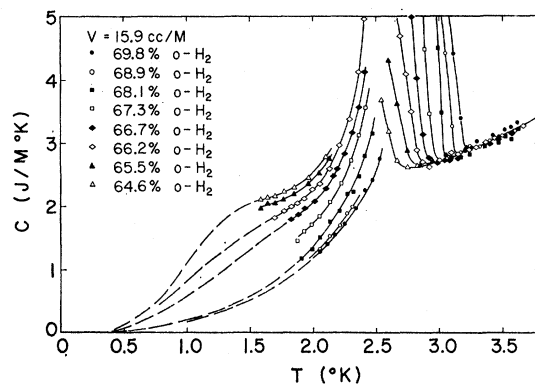

FIG. 12. The heat capacity in the vicinity of the λ anomaly at 15.9 cc/mole at several concentrations.

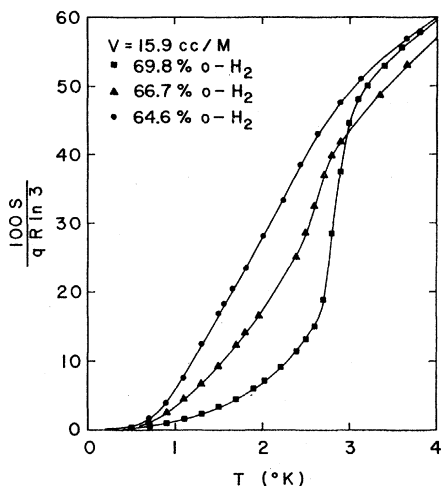

FIG. 13. The entropy of solid hydrogen between 0 and 4°K at three concentrations of orthohydrogen. The small contribution from the cell was not subtracted.

one set of measurements at 15.9 cc/mole. The dashed extrapolations of the experimental data to $T=0$ are of course only approximate and do not permit accurate estimates of entropy changes. Entropy changes calculated from these extrapolations do, however, qualitatively correspond to the entropy lost in the λ anomaly. The entropy as a function of temperature is shown in Fig. 13 for three concentrations of orthohydrogen at 15.9 cc/mole. The entropy shown there includes a small contribution from the entropy of the lattice and the empty cell.

VI. DISCUSSION OF RESULTS

The volume dependence of the λ anomaly was given by Eq. (8). Simple theories of cooperative phenomena indicate that the cooperative transition should have a critical temperature proportional to some linear combination of the various interactions that produce the effect. The volume dependence of T_λ thus strongly supports the idea that the interaction primarily responsible for the anomaly is the electric quadrupole interaction.⁹ At small molar volumes, valence forces start to contribute. The relative contribution of the valence

forces is in qualitative agreement with what might be expected for the Hamiltonian given by Orttung for the interaction between pairs of ortho molecules.¹²

The interpretation of the relative contribution of the λ anomaly to the total anomalous entropy is not at all simple. Qualitatively, one might postulate that only certain types of configurations of n orthomolecules contribute to the λ anomaly where n is some integer. The remainder contributes to the broader anomaly. If any one of the n molecules in a configuration that contributes to the λ anomaly is converted to parahydrogen, then the entire entropy ($nk \ln 3$) of that configuration is lost in the λ anomaly, and $(n-1)k \ln 3$ is added to the entropy of the broad anomaly. This would explain the rapid decrease in the λ anomaly in the absence of self-diffusion. It does not, however, by itself explain why all the entropy of the $(n-1)$ remaining molecules is added at temperatures below the original λ temperature. It is apparent that the energy levels of configurations that do *not* contribute to the λ anomaly also are temperature-dependent. They thus do not produce a heat-capacity contribution of the Schottky type, but rather a contribution that is compressed towards low temperatures.

The interpretation of the existence of at least two distinct maxima in the λ anomaly is equally uncertain. It could be indicative of the presence of two phases. This, however, is considered unlikely because no basic change in the doublets was observed when the molar volume was varied. Alternatively it could be due to two or more different types of configurations, all of which give rise to a λ anomaly.

It can be concluded that the λ anomaly is by far more complicated than simple order-disorder transitions, and that simple theories such as those used by Tomita⁹ need considerable extension before they will be capable of explaining all the features of the anomalous heat capacity of hydrogen at high orthoconcentrations.

ACKNOWLEDGMENTS

The authors are grateful to Dr. Kenneth S. Pitzer for suggesting this problem and for his guidance during the early stages of this work, and to Dr. Norman E. Phillips for his guidance during the later stages.